

Note:

1. All dimensions are in inches (mm)
2. Resistance at 25°C = 70 Ohms ± 50 %
3. Switch temperature = 50 °C TYP
4. Max voltage = 120 Volts

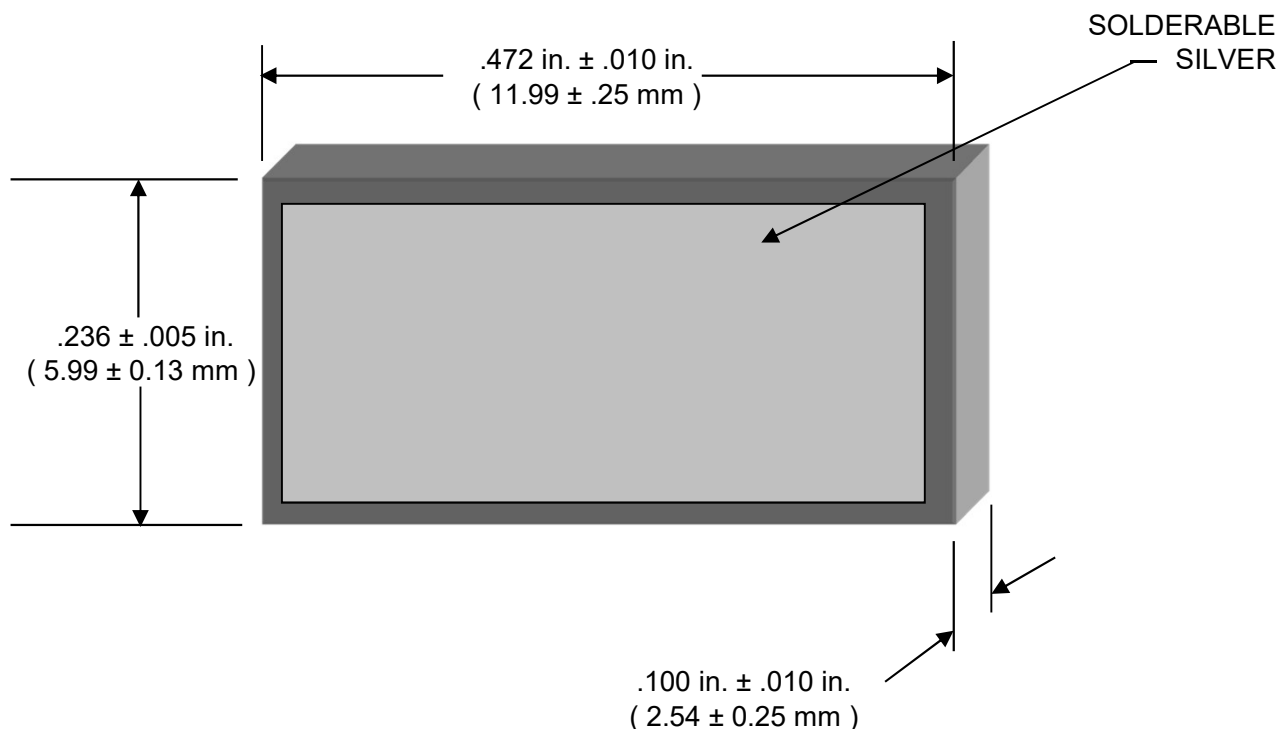

St Marys, PA 15857
 Ph : 814-834-1541
 Fax : 814-834-1556

E-Mail : Greg.Stauffer@thermistorsunlimited.com
 Web Site : www.thermistorsunlimited.com



REVISIONS		
NUM	COMMENTS	BY

NAME : PTC Thermistor
 TYPE: PR421D050S701H

Approved by: GJS BY: ADM DATE: 08-01-2001