

Note:

1. All dimensions are in inches (mm)
2. Resistance at 25°C = 7.0 Ohms ± 20%
3. Switch temperature = 120°C
4. Max voltage = 120 Volts

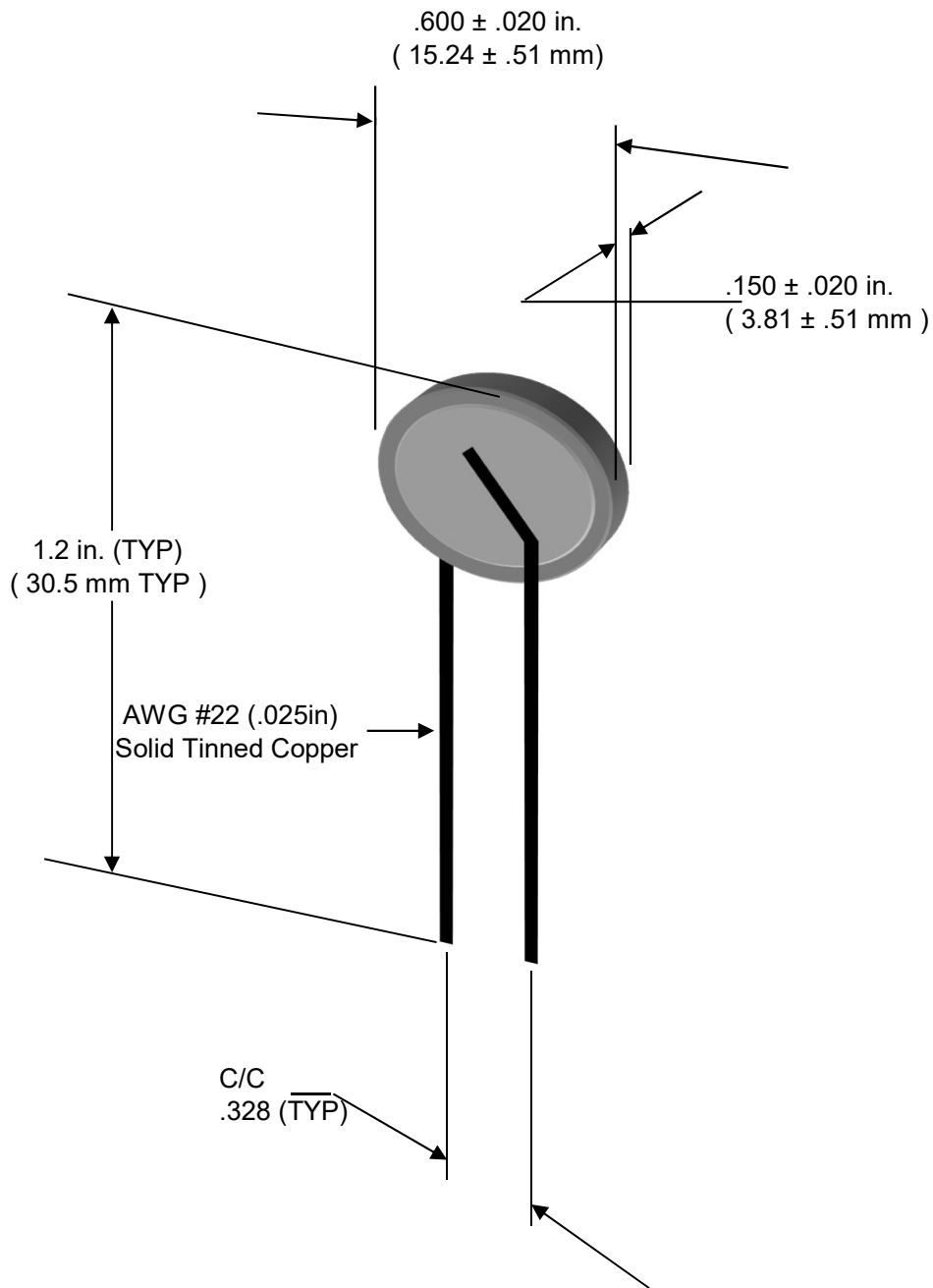

St Marys, PA 15857
Ph : 814-834-1541
Fax : 814-834-1556

E-Mail : Greg.Stauffer@thermistorsunlimited.com
Web Site : www.thermistorsunlimited.com



REVISIONS		
NUM	COMMENTS	BY
01	New Format	GJS
Approved by: GJS		

NAME : PTC Thermistor
TYPE: P6010D120X700F
BY: ADM DATE: 07-19-2001